

BIDDING DOCUMENT
REQUEST FOR PROPOSAL(RFP)

RFP No: Vogal Wheat thresher-2022

National Competitive Bidding
Single Stage-One Envelop

PURCHASE OF VOGAL WHEAT THRESHER

Issued To:	
	Name :
	Date :
Issued By:	

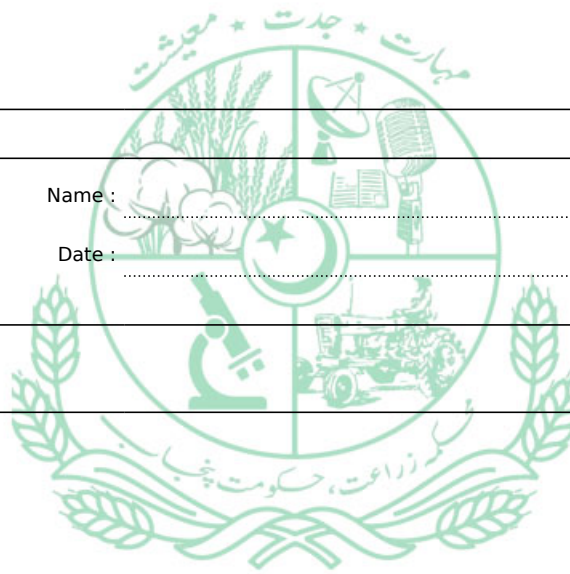

Principal Scientist

**Regional Agricultural Research Institute, Gulberg Road, Model Town-A, Bahawalpur City,
Bahawalpur City, Distt. Bahawalpur
Phone: 92 62 9255 221
Email: directorrari@gmail.com**

July-2022

Table of Content

Grievance Redressal Committee	3
Invitation for Bids	4
Part-I	6
Section I. Instructions to Bidders	6
Part-I Section II. Bid Data Sheet	23
Part-I Items List and Bid Security	28
Part-I Section III. Schedule of Requirements	29
Part-I Section IV. Technical Specifications	30
GENERAL	30
MATERIAL SPECIFICAITONS	30
MISCELLANEOUS	31
Part-I Section V. Bidding Forms	32
Bid Submission Form	32
Price Schedules	35
Part-II	36
Part-II Section I. Contract Forms	36
Contract Form	36
Part-II Section II. General Conditions of Contract	38
Part-II Section III. Special Conditions of Contract	52
Items' Drawing and Specifications	57
Vogal wheat thresher	58
Annexures	59
Undertaking for Correctness of Information and Non-Blacklisting	60
Certificates	62
Power of Attorney (For signatory of Application)	64
Litigation History	66

Grievance Redressal Committee

(Under Rule 67 of Punjab Procurement Rules-2014)

Sr. No.	Name	Designation	Position	Phone	Email	Address
1	Dr. Lal Hussain Akhthar	Principal Scientist	Chairman	92 06 2925 5221	directorrari@gmail.com	Regional Agricultural Research Institute, Gulberg road, Model Road A, Bahawalpur.
2	Asad-ur-Rahman Ch.	Assistant Research Officer	Member	0629255221	sherani639@gmail.com	Regional Agricultural Research Institute, Gulberg road, Model Road A, Bahawalpur.
3	Mr. Naeem Arshad Maan	Scientific Officer	Member	92 06 2925 5221	naemmaan@gmail.com	Regional Agricultural Research Institute, Gulberg road, Model Road A, Bahawalpur.

Invitation for Bids

National Competitive Bidding

Ref: Vogal Wheat thresher-2022

Dated: 26th July, 2022

Principal Scientist has earmarked budget towards the cost of "PURCHASE OF VOGAL WHEAT THRESHER". It is intended that part of the proceeds of this budget will be applied to eligible payments for supply of following item:

Sr. No.	Item	Quantity	Estimated Cost	Bid Security (%)	Bid Security (PKR)
1	Vogal wheat thresher	1.00 (Qty)	400000.00	1.00	4000.00

1. **Principal Scientist**, invites sealed bids for the supply of above mentioned item from General Order Suppliers.
2. Bidding shall be conducted through Open Competitive Bidding **Single Stage-One Envelop** procedure as specified in the Punjab Procurement Rules-2014 (as amended to date) and is open to all eligible bidders as defined in the bidding document.
3. Interested eligible bidders may obtain bidding documents **IMMEDIATELY** from **Regional Agricultural Research Institute, Gulberg Road, Model Town-A, Bahawalpur City, Bahawalpur City, Distt. Bahawalpur** during office hours after payment of PKR 500.00/ -.
4. Sealed Bids must be delivered to the above office **on or before Wednesday, 10th August, 2022 11:00 AM. Proposals** must be accompanied by a **Bid Security as mentioned above** in the form of **Demand Draft, Pay Order, Banker's Cheque or Call at Deposit** duly issued from a Scheduled Bank of Pakistan.
5. **Bids will be opened on Wednesday, 10th August, 2022 11:30 AM in the presence of bidders or their representatives at Regional Agricultural Research Institute, Gulberg Road, Model Town-A, Bahawalpur City, Bahawalpur City, Distt. Bahawalpur** If bid closing/opening date falls on local/national holiday, the date of bid closing/opening shall be the next working day on the same time and venue.
6. The bidders are required to give their **best and final prices** (inclusive of all applicable Taxes) as no negotiations are expected.
7. Bids not complying with the requirements shall be rejected being non-

responsive. Alternate proposals and / or conditional bids shall be considered non-responsive.

8. Taxes will be deducted as per applicable government rules. NTN and Sales Tax registration certificates must be provided with the Bid.
9. Bids which are incomplete, not sealed, not signed and / or not stamped, late or submitted by other than specified mode will be rejected.
10. The contract shall be awarded to the lowest evaluated bidder **Individually for Each Item.**
11. This advertisement and bidding documents are also available on <http://www.agripunjab.gov.pk> and <https://www.ppra.punjab.gov.pk>
12. For obtaining any further information or clarifications, please contact the person named below:

Principal Scientist,
Regional Agricultural Research Institute, Gulberg Road, Model Town-A,
Bahawalpur City, Bahawalpur City, Distt. Bahawalpur

Ph: 92 62 9255 221,

Email: directorrari@gmail.com



Part-I

Section I. Instructions to Bidders

1. Source of Funds

1.1 The Procuring Agency named in the Bid Data Sheet has received budget from the Government of Punjab. The Procuring Agency intends to apply a portion of the proceeds of this budget to eligible payments under the contract for which this Invitation for Bids is issued.

2. Eligible Bidders

2.1 This Invitation for Bids is open to all suppliers, except as provided hereinafter.

2.2 Bidders should not be associated, or have been associated in the past, directly or indirectly, with a firm or any of its affiliates which have been engaged by the Procuring Agency to provide consulting services for the preparation of the design, specifications, and other documents to be used for the procurement of the goods to be purchased under this Invitation for Bids.

2.3 Government-owned enterprises may participate only if they are legally and financially autonomous, if they operate under commercial law, and if they are not a dependent agency of the Government.

2.4 Bidders shall not be under a declaration of blacklisting by any Government department or Punjab Procurement Regulatory Authority (PPRA).

3. Eligible Goods and Services

3.1 All goods and related services to be supplied under the contract shall have their origin in eligible source countries, defined in the Bid Data Sheet (BDS), and all expenditures made under the contract will be limited to such goods and services.

3.2 For purposes of this clause, "origin" means the place where the goods are mined, grown, or produced, or the place from which the related services are supplied. Goods are produced when, through manufacturing, processing, or substantial and major assembly of components, a commercially-recognized product results that is substantially different in basic characteristics or in purpose or utility from its components.

3.3 The origin of goods and services is distinct from the nationality of the Bidder.

4. Cost of Bidding

4.1 The Bidder shall bear all costs associated with the preparation and submission of its bid, and the Procuring Agency named in the Bid Data Sheet, hereinafter referred to as "the Purchaser," will in no case be responsible or liable for those costs, regardless of the conduct or outcome of the bidding process.

B. The Bidding Documents

5. Content of Bidding Documents

5.1 The goods required, bidding procedures, and contract terms are prescribed in the bidding documents. In addition to the Invitation for Bids, the bidding documents include:

- (a) Instructions to Bidders (ITB)
- (b) Bid Data Sheet
- (c) Schedule of Requirements
- (d) Technical Specifications
- (e) Bid Submission Form

(f) Manufacturer's Authorization Form

(g) Price Schedules

(h) Contract Form

(i) Performance Guarantee Form

(j) General Conditions of Contract (GCC)

(k) Special Conditions of Contract (SCC)

5.2 The Bidder is expected to examine all instructions, forms, terms, and specifications in the bidding documents. Failure to furnish all information required by the bidding documents or to submit a bid not substantially responsive to the bidding documents in every respect will be at the Bidder's risk and may result in the rejection of its bid.

6. Clarification of Bidding Documents

6.1 A prospective Bidder requiring any clarification of the bidding documents may notify the Purchaser in writing at the Purchaser's address indicated in ITB Clause 19.1. The Purchaser will respond in writing to any request for clarification of the bidding documents which it receives no later than three (3) days prior to the deadline for the submission of bids prescribed in the Bid Data Sheet. Written copies of the Purchaser's response (including an explanation of the query but without identifying the source of inquiry) will be sent to all prospective bidders that have received the bidding documents.

7. Amendment of Bidding Documents

7.1 At any time prior to the deadline for submission of bids, the Purchaser, for any reason, whether at its own initiative or in response to a clarification requested by a prospective Bidder, may modify the bidding documents by amendment.

7.2 All prospective bidders that have received the bidding documents will be

notified of the amendment in writing and will be bidding on them.

7.3 In order to allow prospective bidders reasonable time in which to take the amendment into account in preparing their bids, the Purchaser, at its discretion, may extend the deadline for the submission of bids.

C. Preparation of Bids

8. Language of Bid

8.1 The bid prepared by the Bidder, as well as all correspondence and documents relating to the bid exchanged by the Bidder and the Purchaser shall be written in the language specified in the Bid Data Sheet. Supporting documents and printed literature furnished by the Bidder may be in same language.

9. Documents Comprising the Bid

9.1 The bid prepared by the Bidder shall comprise the following components:

(a) a Bid Form and a Price Schedule completed in accordance with ITB Clauses 10, 11, and 12;

(b) documentary evidence established in accordance with ITB Clause 13 that the Bidder is eligible to bid and is qualified to perform the contract if its bid is accepted;

(c) documentary evidence established in accordance with ITB Clause 14 that the goods and ancillary services to be supplied by the Bidder are eligible goods and services and conform to the bidding documents; and

(d) bid security furnished in accordance with ITB Clause 15.

10. Bid Form

10.1 The Bidder shall complete the Bid Form and the appropriate Price Schedule furnished in the bidding documents, indicating the goods to be

supplied, a brief description of the goods, their country of origin, quantity, and prices.

11. Bid Prices

11.1 The Bidder shall indicate on the appropriate Price Schedule the unit prices (where applicable) and total bid price of the goods it proposes to supply under the contract.

11.2 Prices indicated on the Price Schedule shall be **delivered duty paid (DDP) prices**.

11.3 The Bidder's separation of price components in accordance with ITB Clause 11.2 above will be solely for the purpose of facilitating the comparison of bids by the Purchaser and will not in any way limit the Purchaser's right to contract on any of the terms offered.

11.4 Prices quoted by the Bidder shall be fixed during the Bidder's performance of the contract and not subject to variation on any account, unless otherwise specified in the Bid Data Sheet. A bid submitted with an **adjustable price quotation** will be treated as nonresponsive and will be rejected, pursuant to ITB Clause 24.

12. Bid Currencies

12.1 Prices shall be quoted in Pak Rupees unless otherwise specified in the Bid Data Sheet.

13. Documents Establishing Bidder's Eligibility and Qualification

13.1 Pursuant to ITB Clause 9, the Bidder shall furnish, as part of its bid, documents establishing the Bidder's eligibility to bid and its qualifications to perform the contract if its bid is accepted.

13.2 The documentary evidence of the Bidder's eligibility to bid shall establish to the Purchaser's satisfaction that the Bidder, at the time of submission of its bid, is eligible as defined under ITB Clause 2.

13.3 The documentary evidence of the Bidder's qualifications to perform the contract if its bid is accepted shall establish to the Purchaser's satisfaction:

(a) that, in the case of a Bidder offering to supply goods under the contract which the Bidder did not manufacture or otherwise produce, the Bidder has been duly authorized by the goods' Manufacturer or producer to supply the goods in Pakistan;

(b) that the Bidder has the financial, technical, and production capability necessary to perform the contract;

(c) that, in the case of a Bidder not doing business within Pakistan, the Bidder is or will be (if awarded the contract) represented by an Agent in that country equipped, and able to carry out the Supplier's maintenance, repair, and spare parts stocking obligations prescribed in the Conditions of Contract and/or Technical Specifications; and

(d) that the Bidder meets the qualification criteria listed in the Bid Data Sheet.

14. Documents Establishing Goods' Eligibility and Conformity to Bidding Documents

14.1 Pursuant to ITB Clause 9, the Bidder shall furnish, as part of its bid, documents establishing the eligibility and conformity to the bidding documents of all goods and services which the Bidder proposes to supply under the contract.

14.2 The documentary evidence of the eligibility of the goods and services shall consist of a statement in the Price Schedule of the country of origin of the goods and services offered which shall be confirmed by a certificate of origin issued at the time of shipment.

14.3 The documentary evidence of conformity of the goods and services to

the bidding documents may be in the form of literature, drawings, and data, and shall consist of:

(a) a detailed description of the essential technical and performance characteristics of the goods;

(b) a list giving full particulars, including available sources and current prices of spare parts, special tools, etc., necessary for the proper and continuing functioning of the goods for a period to be specified in the Bid Data Sheet, following commencement of the use of the goods by the Purchaser; and

(c) an item-by-item commentary on the Purchaser's Technical Specifications demonstrating substantial responsiveness of the goods and services to those specifications, or a statement of deviations and exceptions to the provisions of the Technical Specifications.

14.4 For purposes of the commentary to be furnished pursuant to ITB Clause 14.3(c) above, the Bidder shall note that standards for workmanship, material, and equipment, as well as references to brand names or catalogue numbers designated by the Purchaser in its Technical Specifications, are intended to be descriptive only and not restrictive. The Bidder may substitute alternative standards, brand names, and/or catalogue numbers in its bid, provided that it demonstrates to the Purchaser's satisfaction that the substitutions ensure substantial equivalence to those designated in the Technical Specifications.

15. Bid Security

15.1 Pursuant to ITB Clause 9, the Bidder shall furnish, as part of its bid, a bid security in the amount specified in the Bid Data Sheet.

15.2 The bid security is required to protect the Purchaser against the risk of Bidder's conduct which would warrant the security's forfeiture, pursuant to ITB Clause 15.7.

15.3 The bid security shall be in Pak. Rupees and shall be in one of the

following forms:

(b) Bank call-deposit (CDR), Demand Draft (DD), Pay Order (PO) or Banker's cheque valid for thirty (30) days beyond the validity of bid.

15.4 Any bid not secured in accordance with ITB Clauses 15.1 and 15.3 will be rejected by the Purchaser as nonresponsive, pursuant to ITB Clause 24.

15.5 Unsuccessful bidders' bid security will be discharged or returned as promptly as possible but not later than thirty (30) days after the expiration of the period of bid validity prescribed by the Purchaser pursuant to ITB Clause 16.

15.6 The successful Bidder's bid security will be discharged upon the Bidder signing the contract, pursuant to ITB Clause 32, and furnishing the performance guarantee, pursuant to ITB Clause 33.

15.7 The bid security may be forfeited:

(a) if a Bidder withdraws its bid during the period of bid validity specified by the Bidder on the Bid Form; or

(b) in the case of a successful Bidder, if the Bidder fails:

(i) to sign the contract in accordance with ITB Clause 32;

or

(ii) to furnish performance guarantee in accordance with ITB Clause 33

16. Period of Validity of Bids

16.1 Bids shall remain valid for the period specified in the Bid Data Sheet after the date of bid opening prescribed by the Purchaser, pursuant to ITB Clause 19. A bid valid for a shorter period shall be rejected by the Purchaser as nonresponsive.

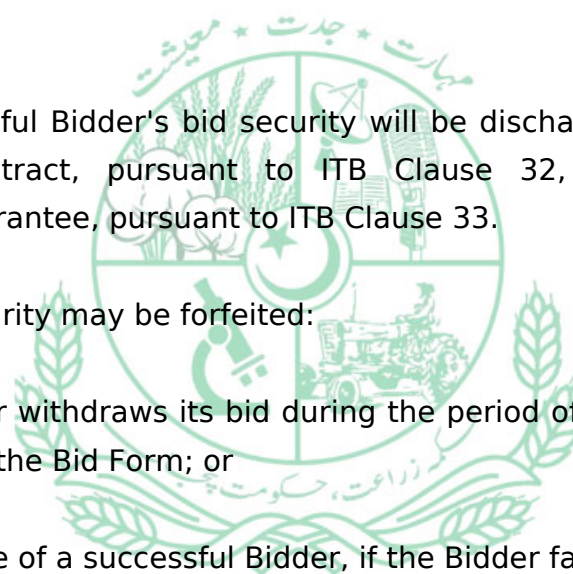

16.2 In exceptional circumstances, the Purchaser may solicit the Bidder's consent to an extension of the period of validity. The request and the responses thereto shall be made in writing. The bid security provided under ITB Clause 15 shall also be suitably extended. A Bidder may refuse the request without forfeiting its bid security. A Bidder granting the request will not be required nor permitted to modify its bid, except as provided in ITB Clause 16.3.

16.3 In the case of fixed price contracts, if the award is delayed by a period exceeding sixty (60) days beyond the expiry of the initial bid validity, the contract price may be adjusted by a factor specified in the request for extension.

17. Format and Signing of Bid

17.1 The Bidder shall prepare an original and the number of copies of the bid indicated in the Bid Data Sheet, clearly marking each "ORIGINAL BID" and "COPY OF BID," as appropriate. In the event of any discrepancy between them, the original shall govern.

17.2 The original and the copy or copies of the bid shall be typed or written in indelible ink and shall be signed by the Bidder or a person or persons duly authorized to bind the Bidder to the contract. All pages of the bid, except for un-amended printed literature, shall be initialed by the person or persons signing the bid.

17.3 Any interlineations, erasures, or overwriting shall be valid only if they are initialed by the person or persons signing the bid.

17.4 The Bidder shall furnish information as described in the Form of Bid on commissions or gratuities, if any, paid or to be paid to agents relating to this Bid, and to contract execution if the Bidder is awarded the contract.

D. Submission of Bids

18. Sealing and Marking of Bids

18.1 The Bidder shall seal the original and each copy of the bid in separate envelopes, duly marking the envelopes as "ORIGINAL" and "COPY." The envelopes shall then be sealed in an outer envelope.

18.2 The inner and outer envelopes shall:

(a) be addressed to the Purchaser at the address given in the Bid Data Sheet; and

(b) bear the title of procurement Activity indicated in the Bid Data Sheet, the Invitation for Bids (IFB) title and number indicated in the Bid Data Sheet, and a statement: "DO NOT OPEN BEFORE," to be completed with the time and the date specified in the Bid Data Sheet.

18.3 The inner envelopes shall also indicate the name and address of the Bidder to enable the bid to be returned unopened in case it is declared "late".

18.4 If the outer envelope is not sealed and marked as required by ITB Clause 18.2, the Purchaser will assume no responsibility for the bid's misplacement or premature opening.

19. Deadline for Submission of Bids

19.1 Bids must be received by the Purchaser at the address specified under ITB Clause 18.2 no later than the time and date specified in the Bid Data Sheet.

19.2 The Purchaser may, at its discretion, extend this deadline for the submission of bids by amending the bidding documents in accordance with ITB Clause 7, in which case all rights and obligations of the Purchaser and bidders previously subject to the deadline will thereafter be subject to the deadline as extended.

20. Late Bids

20.1 Any bid received by the Purchaser after the deadline for submission of

bids prescribed by the Purchaser pursuant to ITB Clause 19 will be rejected and returned unopened to the Bidder.

21. Modification and Withdrawal of Bids

21.1 The Bidder may modify or withdraw its bid after the bid's submission, provided that written notice of the modification, including substitution or withdrawal of the bids, is received by the Purchaser prior to the deadline prescribed for submission of bids.

21.2 The Bidder's modification or withdrawal notice shall be prepared, sealed, marked, and dispatched in accordance with the provisions of ITB Clause 18. A withdrawal notice may also be sent by email, but followed by a signed confirmation copy, postmarked not later than the deadline for submission of bids.

21.3 No bid may be modified after the deadline for submission of bids.

21.4 No bid may be withdrawn in the interval between the deadline for submission of bids and the expiration of the period of bid validity specified by the Bidder on the Bid Form. Withdrawal of a bid during this interval may result in the Bidder's forfeiture of its bid security, pursuant to the ITB Clause 15.7.

E. Opening and Evaluation of Bids

22. Opening of Bids by the Purchaser

22.1 The Purchaser will open all bids in the presence of bidders' representatives who choose to attend, at the time, on the date, and at the place specified in the Bid Data Sheet. The bidders' representatives who are present shall sign an attendance sheet evidencing their presence.

22.2 The bidders' names, bid modifications or withdrawals, bid prices, discounts, and the presence or absence of requisite bid security and such other details as the Purchaser, at its discretion, may consider appropriate, will be announced at the opening. No bid shall be rejected at bid opening,

except for late bids, which shall be returned unopened to the Bidder pursuant to ITB Clause 20.

22.3 Bids (and modifications sent pursuant to ITB Clause 21.2) that are not opened and read out at bid opening shall not be considered further for evaluation, irrespective of the circumstances. Withdrawn bids will be returned unopened to the bidders.

22.4 The Purchaser will prepare minutes of the bid opening.

23. Clarification of Bids

23.1 During evaluation of the bids, the Purchaser may, at its discretion, ask the Bidder for a clarification of its bid. The request for clarification and the response shall be in writing, and no change in the prices or substance of the bid shall be sought, offered, or permitted.

24. Preliminary Examination

24.1 The Purchaser will examine the bids to determine whether they are complete, whether any computational errors have been made, whether required sureties have been furnished, whether the documents have been properly signed, and whether the bids are generally in order.

24.2 Arithmetical errors will be rectified on the following basis. If there is a discrepancy between the unit price and the total price that is obtained by multiplying the unit price and quantity, the unit price shall prevail, and the total price shall be corrected. If the Supplier does not accept the correction of the errors, its bid will be rejected, and its bid security may be forfeited. If there is a discrepancy between words and figures, the amount in words will prevail.

24.3 The Purchaser may waive any minor informality, nonconformity, or irregularity in a bid which does not constitute a material deviation, provided such waiver does not prejudice or affect the relative ranking of any Bidder.

24.4 Prior to the detailed evaluation, pursuant to ITB Clause 25 the Purchaser

will determine the substantial responsiveness of each bid to the bidding documents. For purposes of these Clauses, a substantially responsive bid is one which conforms to all the terms and conditions of the bidding documents without material deviations. Deviations from, or objections or reservations to critical provisions, **such as** those concerning **Bid Security** (ITB Clause 15), **Applicable Law** (GCC Clause 30), and **Taxes and Duties** (GCC Clause 32), will be deemed to be a material deviation. The Purchaser's determination of a bid's responsiveness is to be based on the contents of the bid itself without recourse to extrinsic evidence.

24.5 If a bid is not substantially responsive, it will be rejected by the Purchaser and may not subsequently be made responsive by the Bidder by correction of the nonconformity.

25. Qualification & Evaluation of Bids

25.1 In the absence of **prequalification**, the Purchaser will determine to its satisfaction whether the Bidder is qualified to perform the contract satisfactorily, in accordance with the criteria listed in ITB Clause 13.3.

25.2 The determination will take into account the Bidder's financial, technical, and production capabilities. It will be based upon an examination of the documentary evidence of the Bidder's qualifications submitted by the Bidder, pursuant to ITB Clause 13.3, as well as such other information as the Purchaser deems necessary and appropriate.

25.3 The Purchaser will **technically evaluate** and compare the bids which have been determined to be substantially responsive, pursuant to ITB Clause 24, as per Technical Specifications required.

25.4 The Purchaser's financial evaluation of a bid will be on delivered duty paid (DDP) price inclusive of prevailing taxes and duties.

Alternate 25.5 Quality & Cost-based Selection:

The following merit point system for weighing evaluation factors can be applied if specified in the Bid Data Sheet. The number of points allocated to

each factor shall be specified in the Bid Data Sheet.

[In the Bid Data Sheet, choose from the range of]

Price of the goods	60 to 90
Quality, technology and metallurgy	0 to 20
Performance and productivity	0 to 20
Standardization	0 to 20
Projected life-cycle cost	0 to 20
Operating and maintenance costs	0 to 20
Cost of spare parts and after-sales-service	0 to 20
Total	100

The bid scoring the highest number of points will be deemed to be the lowest evaluated bid.

26. Contacting the Purchaser

26.1 Subject to ITB Clause 23, no Bidder shall contact the Purchaser on any matter relating to its bid, from the time of the bid opening to the time evaluation report is made public i.e. 10 days before the contract is awarded. If the Bidder wishes to bring additional information or has grievance to the notice of the Purchaser, it should do so in writing.

26.2 Any effort by a Bidder to influence the Purchaser during bid evaluation, or bid comparison may result in the rejection of the Bidder's bid.

F. Award of Contract

28. Award Criteria

28.1 Subject to ITB Clause 30, the Purchaser will award the contract to the successful Bidder whose bid has been determined to be substantially responsive and has been determined to be the lowest evaluated bid, provided further that the Bidder is determined to be qualified to perform the

contract satisfactorily.

29. Purchaser's Right to Vary Quantities at Time of Award

29.1 The Purchaser reserves the right at the time of contract award to increase or decrease, by the percentage indicated in the Bid Data Sheet, the quantity of goods and services originally specified in the Schedule of Requirements without any change in unit price or other terms and conditions.

30. Purchaser's Right to Accept or Reject All Bids

30.1 The Purchaser reserves the right to accept or reject all bids, and to annul the bidding process at any time prior to contract award, without thereby incurring any liability to the Bidder or bidders or any obligation to inform the Bidder or bidders of the grounds for the Purchaser's action.

31. Notification of Award

31.1 Prior to the expiration of the period of bid validity, the Purchaser will notify the successful Bidder in writing that its bid has been accepted.

31.2 Upon the successful Bidder's furnishing of the performance guarantee pursuant to ITB Clause 33, the Purchaser will promptly notify each unsuccessful Bidder and will discharge its bid security, pursuant to ITB Clause 15.

32. Signing of Contract

32.1 At the same time as the Purchaser notifies the successful Bidder that its bid has been accepted, the Purchaser will send the Bidder the Contract Form provided in the bidding documents, incorporating all agreements between the parties.

32.2 Within Ten (10) days of the issuance of Contract Award Notification, the successful Bidder shall sign and date the contract and return it to the Purchaser.

33. Performance Guarantee

33.1 Within Ten (10) days of the receipt of notification of award from the Purchaser, the successful Bidder shall furnish the performance guarantee in accordance with the Conditions of Contract, in the performance guarantee Form provided in the bidding documents, or in another form acceptable to the Purchaser.

33.2 Failure of the successful Bidder to comply with the requirement of ITB Clause 32 or ITB Clause 33.1 shall constitute sufficient grounds for the annulment of the award and forfeiture of the bid security, in which event the Purchaser may make the award to the next lowest evaluated Bidder or call for new bids.

34. Corrupt or Fraudulent Practices

34.1 The Procuring Agency requires that Bidders, Suppliers, and Contractors observe the highest standard of ethics during the procurement and execution of contracts. For the purposes of this provision, the terms set forth below are defined as follows:

(a)

(i) "corrupt practice" means the offering, giving, receiving or soliciting of anything of value to influence the action of a public official in the procurement process or in contract execution; and

(ii) "fraudulent practice" means a misrepresentation of facts in order to influence a procurement process or the execution of a contract to the detriment of the Procuring Agency,

(iii) "collusive practice" is an arrangement among bidders (prior to or after bid submission) designed to establish bid prices at artificial, non-competitive levels for any wrongful gains, and to deprive the Procuring Agency of the benefits of free and open competition;

(b)The Procuring Agency will reject a proposal for award if it determines that the Bidder recommended for award has engaged in corrupt or fraudulent practices in competing for the contract in question;

(c)The Procuring Agency will sanction a firm, in accordance with prevailing Blacklisting procedures under Punjab Procurement Rules 2014, if it at any time determines that the firm has engaged in corrupt or fraudulent practices in competing for, or in executing, a Bank-financed contract.

34.2 Furthermore, Bidders shall be aware of the provision stated in sub-clause 5.4 and sub-clause 24.1 of the General Conditions of Contract.



Part-I

Section II. Bid Data Sheet

The following specific data for the goods to be procured shall complement, supplement, or amend the provisions in the Instructions to Bidders (ITB) Part One. Whenever there is a conflict, the provisions herein shall prevail over those in ITB.

Introduction

ITB 1.1

Name of Procuring Agency: **Principal Scientist, Regional Agricultural Research Institute, Gulberg Road, Model Town-A, Bahawalpur City, Bahawalpur City, Distt. Bahawalpur**

Name of Project:

Name of Contract: **PURCHASE OF VOGAL WHEAT THRESHER**

ITB 4.1

Name of Purchaser: **Principal Scientist**

ITB 6.1

For clarification purposes, the Employer's address is:
Regional Agricultural Research Institute, Gulberg Road, Model Town-A, Bahawalpur City, Bahawalpur City, Distt. Bahawalpur

Requests for clarification shall be received by the Employer no Later than
Thursday, 28th July, 2022

ITB 8.1

Language of the bid: **English**

Bid Price and Currency

ITB 11.2

The price quoted shall be **Delivered Duty Paid** at the locations mentioned in the Schedule of Requirements.

ITB 11.4

The price shall be in **Pak Rupees** and shall be fixed.

Preparation and Submission of Bids

ITB 13.2

Eligibility Requirements of the Bidder:

1. Registration with Federal Board of Revenue (FBR) for Income Tax and General Sales Tax (GST) with active status on Active Taxpayer List (ATL) of FBR
2. Fulfilling all requirements of CLAUSE 2 ("Eligible Bidders") of Instructions to Bidders
3. An affidavit for Correctness of Information & Non-Blacklisting on prescribed format (See Annexures)
4. **Power of Attorney** (see Annexures for template) from the Bidding Firm / Company authorizing the relevant person to represent it (if applicable).
5. Undertaking on Judicial Paper that the firm fulfills eligibility requirements of ITB Clause 2, is not blacklisted and not involved in litigation with any of provincial or Federal Government Department, Agency, Organization or autonomous body anywhere in Pakistan. In case involved in any litigation process, proof of dispute resolution is required.

Note: In case of exemption from any tax, valid Tax Exemption Certificate shall also be attached.

ITB 13.3

Qualification Requirements of Bidder. In addition to ITB 13.1, ITB 13.2, and ITB 13.3 (b), the potential bidder must also fulfill the following:-

1. The Bidder must be a **General Order Suppliers** for sales & service of the goods continuously for last one-year.
2. The bidder must have at least one local certified /authorized **repair and maintenance set-up**.
3. Description of bidder's own **repair & maintenance set-up** with the location / addresses of workshops, mobile workshops (if any).
4. Income Tax Returns for the last 2 years showing at least an average gross annual sales from this business which shall not be less than twice the amount of this procurement
5. Technical Brochures of Equipment quoted, mentioning its specifications, manufacture's model product number, and country of origin.
6. The bidder shall provide samples of the requisite part along with the bid for its performance, physical, analytical and metallurgical tests; eligibility of the bidder is dependent on the satisfactory test reports of the samples, however the parts of those manufacturers/Brands, which have already accepted by the Department after test may be exempted from performance test, hardness test/material composition text etc.
7. In case, the bidders offer genuine parts or parts of those brand/manufacturers which were supplied during the year 2016-18 and which have already been accepted by the Department after successful operation are exempted from submission of samples alongwith the bids
8. If an Agent submits bids on the behalf of more than one manufacturer, unless each such bid is accompanied by a separate Bid From for each bid, and a bid security, when required, for each bid, and a valid authorized dealership certificate from the respective Manufacturer, all such bids will be rejected as nonresponsive.

ITB 14.3 (a)

The Bidder shall attach with the Bid **Technical Brochures** of Equipment quoted, mentioning its specifications, manufacture's model, product number, and country of origin **(if applicable)**.

ITB 14.3 (b)

A certificate from the dealer that all spare parts of the equipment to be supplied are easily available in Pakistan in the local market or from company owned outlets **(if applicable)**.

ITB 15.1

Amount of Bid Security:

Bids shall be on the prescribed format, sealed and accompanied by the Bid Security in the form of **Demand Draft, Pay Order, Banker's Cheque or Call at Deposit** in favor of **Principal Scientist** having its **validity till 8th March,2023**.

The complete list of items and their bid security is defined ahead under the section **Items List and Bid Security**.

ITB 16.1

Bid Validity Period: 180 days after the date of opening of bid.

ITB 17.1

The bids shall be submitted in the format of **Single Stage-One Envelop**.

Number of Copies: Original along with 1 Copy(ies) of the bid.

This envelope shall be addressed to **Principal Scientist**, Regional Agricultural Research Institute, Gulberg Road, Model Town-A, Bahawalpur City, Bahawalpur City, Distt. Bahawalpur, with name & address of the bidder.

ITB 18.2 (a)

Address for Bid Submission: Regional Agricultural Research Institute, Gulberg Road, Model Town-A, Bahawalpur City, Bahawalpur City, Distt. Bahawalpur

ITB 18.2 (b)

IFB Title and Number: PURCHASE OF VOGAL WHEAT THRESHER Ref: Vogal Wheat thresher-2022

ITB 19.1

Deadline for Bid Submission: Wednesday, 10th August, 2022 11:00 AM

ITB 22.1

Time, Date, and Place for Bid Opening:

Time: 11:30 AM

Date: Wednesday, 10th August, 2022

Place: Regional Agricultural Research Institute, Gulberg Road, Model Town-A, Bahawalpur City, Bahawalpur City, Distt. Bahawalpur

Bid Evaluation

ITB 25.3

Criteria for bid evaluation: Substantively responsive bid (from qualified bidder) offering the lowest Delivered Duty Paid (DDP) price Individually for Each Item.

Contract Award

ITB 29.1

Percentage for quantity increase or decrease:

Percentage for quantity increase : 15.00 % of total contract value

Percentage for quantity decrease: 15.00 % of total contract value

Part-I

Items List and Bid Security

Sr. No.	Item	Quantity	Bid Security (PKR)
1	Vogal wheat thresher	1.00 (Qty)	1.00% of Rs. 400000.00



Part-I

Section III. Schedule of Requirements

Sr. No.	Item	Quantity	Tentative Delivery Period from the Date of Notification of Award Contract	Delivery Location
1	Vogal wheat thresher	1.00(Qty)	6 Days	Regional Agricultural Research Institute, Gulberg Road, Model Town-A, Bahawalpur City

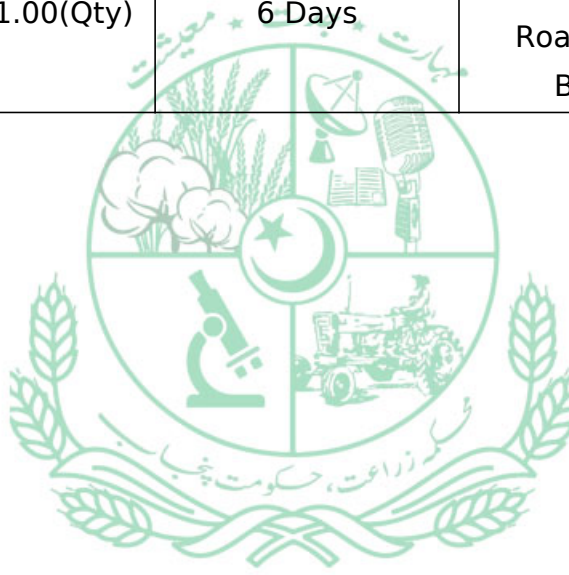

Part-I

Section IV. Technical Specifications

Vogal wheat thresher

Required Specifications:

GENERAL

Application	For threshing of small experimental trials of wheat crop		
Hitching	Tow-hook		
Prime mover	5 hp electric motor and 9 hp HSD engine having circulation of water pump with an additional water tank		
Threshing drum			
Size	316 mm dia., 510 mm long		
Speed	600-700 rpm		
Pegs	75 Nos. on threshing drum and 28 Nos. bolted on 6 mm MS sheet of drum cover		
Capacity	25 kg/hr		
Tyres	02 Nos. pneumatic 6.00 - 14 with double bearings		
No. of blowers	01, adjustable for air vent and extended		
Bearings	Sealed or with grease system		
Drive system	V-belts, pulleys B-type Reciprocating system		
	Cradle supported with bearings <u>OVERALL DIMENTIONS (MIN)</u>		

Length (with tow hook)	3020 mm	Width (with tyres)	1440 mm
Height (with tyres)	2140 mm		
Weight	500 kg		

MATERIAL SPECIFICAITONS

Frame	96x40x6 mm MS channel box, 50x30x6 mm MS channel and 36x36x5 mm MS angle with supports of 25x25x4 mm MS angle		
Hook	25 mm M.S round with tow system welded with		

76x36x6 mm MS channel	
Sheet metal	
Drum cover	14 gauge
Hoppers	16 gauge
Grain outlets	16 gauge
Sieves	16 gauge
Cutters	Heat treated/ Hardened steel
Thresher shaft	38 mm M.S round cold drawn
Beater shaft	25 mm M.S round cold drawn
CAM shaft	25 mm M.S round cold drawn
Blower	04 Nos. flaps, 150 mm wide, 4 mm MS sheet
Blower shaft	20 mm M.S round cold drawn
Parking Stand	50 mm dia., 4 mm thick MS pipe with adj. holes

MISCELLANEOUS

Paint	Double coat with primer after surface finish
Nuts and bolts	to be tightened with spring washers
Bearings (New)	European Standards
Modifications	To be carried out free of cost, if required
Warranty	Free: 1 year for parts and service Extended: 5 years for parts supply on payment

Note: Check **Drawing specification** attached in **Drawing Section** of this document

Part-I
Section V. Bidding Forms

Bid Submission Form

REF: **Vogal Wheat thresher-2022**

Date: -----

No: -----

To

Principal Scientist, Regional Agricultural Research Institute, Gulberg Road, Model Town-A, Bahawalpur City, Bahawalpur City, Distt. Bahawalpur

Having examined the bidding documents including Addenda Nos. *[insert numbers]*, the receipt of which is hereby duly acknowledged, we, the undersigned, offer to supply and deliver goods under the contract **PURCHASE OF VOGAL WHEAT THRESHER** in conformity with the said bidding documents for the sum of *[total bid amount in words and figures]* or such other sums as may be ascertained in accordance with the Schedule of Prices attached herewith and made part of this Bid.

We undertake, if our Bid is accepted, to deliver the goods in accordance with the delivery schedule specified in the Schedule of Requirements.

We agree to abide by this Bid for a period of 180 days from the date fixed for Bid opening under Clause 22 of the Instructions to Bidders, and it shall remain binding upon us and may be accepted at any time before the expiration of that period.

Until a formal Contract is prepared and executed, this Bid, together with your written acceptance thereof and your notification of award, shall constitute a binding Contract between us.

Commissions or gratuities, if any, paid or to be paid by us to agents relating to this Bid, and to contract execution if we are awarded the contract, are listed below:

Name and address of agent

Amount and Currency

Purpose of Commission or gratuity



(if none, state "none")

We understand that you are not bound to accept the lowest or any bid you may receive.

Dated this _____ day of _____ 20_____.

[signature]

[in the capacity of]

Duly authorized to sign Bid for and on behalf of _____.



Price Schedules

Sr. No.	Item / Description	Quantity	Brand / Model	Country / Origin	Unit Price (PKR)	Sub Total
1	Vogal wheat thresher	1.00(Qty)				
Grand Total :						



Part-II

Part-II

Section I. Contract Forms

Contract Form

THIS AGREEMENT made the ____ day of _____ 20____ between **Principal Scientist, Regional Agricultural Research Institute, Gulberg Road, Model Town-A, Bahawalpur City, Bahawalpur City, Distt. Bahawalpur** (hereinafter called "the Purchaser") of the one part and *[name of Supplier]* of (hereinafter called "the Supplier") of the other part:

WHEREAS the Purchaser invited bids for certain goods and ancillary services, viz., **PURCHASE OF VOGAL WHEAT THRESHER** and has accepted a bid by the Supplier for the supply of those goods and services in the sum of *[contract price in words and figures]* (hereinafter called "the Contract Price").

NOW THIS AGREEMENT WITNESSETH AS FOLLOWS:

1. In this Agreement words and expressions shall have the same meanings as are respectively assigned to them in the Conditions of Contract referred to.
2. The following documents shall be deemed to form and be read and construed as part of this Agreement, viz.:
 - the Bid Form and the Price Schedule submitted by the Bidder;
 - the Schedule of Requirements;
 - the Technical Specifications;
 - the General Conditions of Contract;
 - the Special Conditions of Contract; and
 - the Purchaser's Notification of Award.
3. In consideration of the payments to be made by the Purchaser to the Supplier as hereinafter mentioned, the Supplier hereby covenants with the Purchaser to provide the goods and services and to remedy defects therein

in conformity in all respects with the provisions of the Contract

4. The Purchaser hereby covenants to pay the Supplier in consideration of the provision of the goods and services and the remedying of defects therein, the Contract Price or such other sum as may become payable under the provisions of the contract at the times and in the manner prescribed by the contract.

IN WITNESS whereof the parties hereto have caused this Agreement to be executed in accordance with their respective laws the day and year first above written.

Signed, sealed, delivered by _____ the _____ (for the Purchaser)

Signed, sealed, delivered by _____ the _____ (for the Supplier)

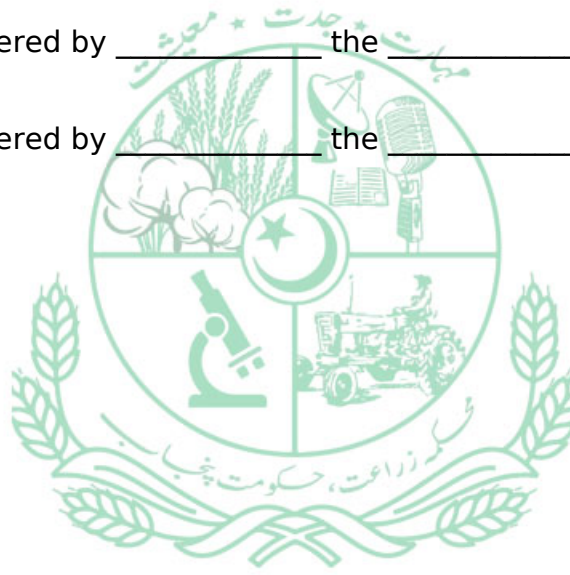

Part-II

Section II. General Conditions of Contract

1. Definitions

1.1 In this Contract, the following terms shall be interpreted as indicated:

(a) "The Contract" means the agreement entered into between the Purchaser and the Supplier, as recorded in the Contract Form signed by the parties, including all attachments and appendices thereto and all documents incorporated by reference therein.

(b) "The Contract Price" means the price payable to the Supplier under the Contract for the full and proper performance of its contractual obligations.

(c) "The Goods" means all of the equipment, machinery, and/or other materials which the Supplier is required to supply to the Purchaser under the Contract.

(d) "The Services" means those services ancillary to the supply of the Goods, such as transportation and insurance, and any other incidental services, such as installation, commissioning, provision of technical assistance, training, and other such obligations of the Supplier covered under the Contract.

(e) "GCC" means the General Conditions of Contract contained in this section.

(f) "SCC" means the Special Conditions of Contract.

(g) "The Purchaser" means the organization purchasing the Goods, as named in SCC.

(h) "The Purchaser's country" is Islamic Republic of Pakistan.

(i) "The Supplier" means the individual or firm supplying the Goods and

Services under this Contract.

(j) "The Project Site," where applicable, means the place or places named in SCC.

(k) "Day" means calendar day.

2. Application

2.1 These General Conditions shall apply to the extent that they are not superseded by provisions of other parts of the Contract.

3. Country of Origin

3.1 For purposes of this Clause, "origin" means the place where the Goods were mined, grown, or produced, or from which the Services are supplied. Goods are produced when, through manufacturing, processing, or substantial and major assembly of components, a commercially recognized new product results that is substantially different in basic characteristics or in purpose or utility from its components.

3.2 The origin of Goods and Services is distinct from the nationality of the Supplier.

4. Standards

4.1 The Goods supplied under this Contract shall conform to the standards mentioned in the Technical Specifications, and, when no applicable standard is mentioned, to the authoritative standards appropriate to the Goods' country of origin. Such standards shall be the latest issued by the concerned institution

5. Use of Contract Documents and Information; Inspection and Audit by the Purchaser

5.1 The Supplier shall not, without the Purchaser's prior written consent, disclose the Contract, or any provision thereof, or any specification, plan, drawing, pattern, sample, or information furnished by or on behalf of the Purchaser in connection therewith, to any person other than a person

employed by the Supplier in the performance of the Contract. Disclosure to any such employed person shall be made in confidence and shall extend only so far as may be necessary for purposes of such performance.

5.2 The Supplier shall not, without the Purchaser's prior written consent, make use of any document or information enumerated in GCC Clause 5.1 except for purposes of performing the Contract.

5.3 Any document, other than the Contract itself, enumerated in GCC Clause 5.1 shall remain the property of the Purchaser and shall be returned (all copies) to the Purchaser on completion of the Supplier's performance under the Contract if so required by the Purchaser.

5.4 The Supplier shall permit the Procuring Agency to inspect the Supplier's accounts and records relating to the performance of the Supplier and to have them audited by auditors appointed by the Procuring Agency, if so required by the Procuring Agency.

6. Patent Rights

6.1 The Supplier shall indemnify the Purchaser against all third party claims of infringement of patent, trademark, or industrial design rights arising from use of the Goods or any part thereof.

7. Performance Guarantee

7.1 Within ten (10) days of receipt of the notification of Contract award, the successful Bidder shall furnish to the Purchaser the performance guarantee in the amount specified in SCC.

7.2 The proceeds of the performance guarantee shall be payable to the Purchaser as compensation for any loss resulting from the Supplier's failure to complete its obligations under the Contract.

7.3 The performance guarantee shall be denominated in the currency of the Contract acceptable to the Purchaser and shall be in one of the following forms:

(a) a bank guarantee or an irrevocable letter of credit issued by a reputable bank located in Pakistan, in the form provided in the bidding documents or another form acceptable to the Purchaser; or

(b) a cashier's or certified check.

7.4 The performance guarantee will be discharged by the Purchaser and returned to the Supplier not later than thirty (30) days following the date of completion of the Supplier's performance obligations under the Contract, including any warranty obligations, unless specified otherwise in SCC.

8. Inspections and Tests

8.1 The Purchaser or its representative shall have the right to inspect and/or to test the Goods to confirm their conformity to the Contract specifications at no extra cost to the Purchaser. SCC and the Technical Specifications shall specify what inspections and tests the Purchaser requires and where they are to be conducted. The Purchaser shall notify the Supplier in writing, in a timely manner, of the identity of any representatives retained for these purposes.

8.2 The inspections and tests may be conducted on the premises of the Supplier or its subcontractor(s), at point of delivery, and/or at the Goods' final destination. If conducted on the premises of the Supplier or its subcontractor(s), all reasonable facilities and assistance, including access to drawings and production data, shall be furnished to the inspectors at no charge to the Purchaser.

8.3 Should any inspected or tested Goods fail to conform to the Specifications, the Purchaser may reject the Goods, and the Supplier shall either replace the rejected Goods or make alterations necessary to meet specification requirements free of cost to the Purchaser.

8.4 The Purchaser's right to inspect, test and, where necessary, reject the Goods after the Goods' arrival in Pakistan shall in no way be limited or waived by reason of the Goods having previously been inspected, tested, and passed by the Purchaser or its representative prior to the Goods' shipment from the country of origin.

8.5 Nothing in GCC Clause 8 shall in any way release the Supplier from any warranty or other obligations under this Contract.

9. Packing

9.1 The Supplier shall provide such packing of the Goods as is required to prevent their damage or deterioration during transit to their final destination, as indicated in the Contract. The packing shall be sufficient to withstand, without limitation, rough handling during transit and exposure to extreme temperatures, salt and precipitation during transit, and open storage. Packing case size and weights shall take into consideration, where appropriate, the remoteness of the Goods' final destination and the absence of heavy handling facilities at all points in transit.

9.2 The packing, marking, and documentation within and outside the packages shall comply strictly with such special requirements as shall be expressly provided for in the Contract, including additional requirements, if any, specified in SCC, and in any subsequent instructions ordered by the Purchaser.

10. Delivery and Documents

10.1 Delivery of the Goods shall be made by the Supplier in accordance with the terms specified in the Schedule of Requirements. The details of shipping and/or other documents to be furnished by the Supplier are specified in SCC.

10.2 Documents to be submitted by the Supplier are specified in SCC

11. Insurance

11.1 The Goods supplied under the Contract shall be delivered duty paid (DDP) under which risk is transferred to the buyer after having been delivered, hence insurance coverage is sellers responsibility.

12. Transportation

12.1 The Supplier is required under the Contact to transport the Goods to a specified place of destination within the Purchaser's country, transport to such place of destination in the Purchaser's country, including insurance and storage, as shall be specified in the Contract, shall be arranged by the Supplier, and related costs shall be included in the Contract Price.

13. Incidental Services

13.1 The Supplier may be required to provide any or all of the following services, including additional services, if any, specified in SCC:

(a) performance or supervision of on-site assembly and/or start up of the supplied Goods;

(b) furnishing of tools required for assembly and/or maintenance of the supplied Goods;

(c) furnishing of a detailed operations and maintenance manual for each appropriate unit of the supplied Goods;

(d) performance or supervision or maintenance and/or repair of the supplied Goods, for a period of time agreed by the parties, provided that this service shall not relieve the Supplier of any warranty obligations under this Contract; and

(e) training of the Purchaser's personnel, at the Supplier's plant and/or on-site, in assembly, start-up, operation, maintenance, and/or repair of the supplied Goods.

13.2 Prices charged by the Supplier for incidental services, if not included in

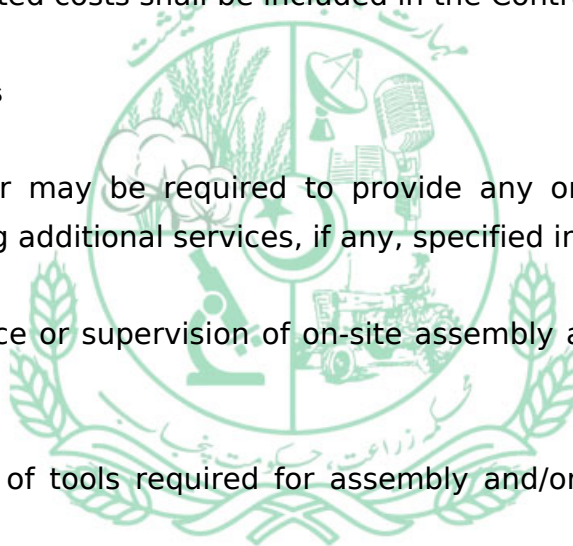

the Contract Price for the Goods, shall be agreed upon in advance by the parties and shall not exceed the prevailing rates charged for other parties by the Supplier for similar services.

14. Spare Parts

14.1 As specified in SCC, the Supplier may be required to provide any or all of the following materials, notifications, and information pertaining to spare parts manufactured or distributed by the Supplier:

(a) such spare parts as the Purchaser may elect to purchase from the Supplier, provided that this election shall not relieve the Supplier of any warranty obligations under the Contract; and

(b) in the event of termination of production of the spare parts:

(i) advance notification to the Purchaser of the pending termination, in sufficient time to permit the Purchaser to procure needed requirements; and

(ii) following such termination, furnishing at no cost to the Purchaser, the blueprints, drawings, and specifications of the spare parts, if requested.

15. Warranty

15.1 The Supplier warrants that the Goods supplied under the Contract are new, unused, of the most recent or current models, and that they incorporate all recent improvements in design and materials unless provided otherwise in the Contract. The Supplier further warrants that all Goods supplied under this Contract shall have no defect, arising from design, materials, or workmanship (except when the design and/or material is required by the Purchaser's specifications) or from any act or omission of the Supplier, that may develop under normal use of the supplied Goods in the conditions prevailing in the country of final destination.

15.2 This warranty shall remain valid for twelve (12) months after the Goods, or any portion thereof as the case may be, have been delivered to and

accepted at the final destination indicated in the Contract, or for eighteen (18) months after the date of shipment from the port or place of loading in the source country, whichever period concludes earlier, unless specified otherwise in SCC.

15.3 The Purchaser shall promptly notify the Supplier in writing of any claims arising under this warranty.

15.4 Upon receipt of such notice, the Supplier shall, within the period specified in SCC and with all reasonable speed, repair or replace the defective Goods or parts thereof, without costs to the Purchaser.

15.5 If the Supplier, having been notified, fails to remedy the defect(s) within the period specified in SCC, within a reasonable period, the Purchaser may proceed to take such remedial action as may be necessary, at the Supplier's risk and expense and without prejudice to any other rights which the Purchaser may have against the Supplier under the Contract.

16. Payment

16.1 The method and conditions of payment to be made to the Supplier under this Contract shall be specified in SCC.

16.2 The Supplier's request(s) for payment shall be made to the Purchaser in writing, accompanied by an invoice describing, as appropriate, the Goods delivered and Services performed, and by documents submitted pursuant to GCC Clause 10, and upon fulfillment of other obligations stipulated in the Contract.

16.3 Payments shall be made promptly by the Purchaser, but in no case later than thirty (30) days after submission of an invoice or claim by the Supplier.

16.4 The currency of payment is Pak. Rupees.

17. Prices

17.1 Prices charged by the Supplier for Goods delivered and Services

performed under the Contract shall not vary from the prices quoted by the Supplier in its bid, with the exception of any price adjustments authorized in SCC or in the Purchaser's request for bid validity extension, as the case may be.

18. Change Orders

18.1 The Purchaser may at any time, by a written order given to the Supplier pursuant to GCC Clause 31, make changes within the general scope of the Contract in any one or more of the following:

(a) drawings, designs, or specifications, where Goods to be furnished under the Contract are to be specifically manufactured for the Purchaser;

(b) the method of shipment or packing;

(c) the place of delivery; and/or

(d) the Services to be provided by the Supplier.

18.2 If any such change causes an increase or decrease in the cost of, or the time required for, the Supplier's performance of any provisions under the Contract, an equitable adjustment shall be made in the Contract Price or delivery schedule, or both, and the Contract shall accordingly be amended. Any claims by the Supplier for adjustment under this clause must be asserted within thirty (30) days from the date of the Supplier's receipt of the Purchaser's change order.

19. Contract Amendments

19.1 Subject to GCC Clause 18, no variation in or modification of the terms of the Contract shall be made except by written amendment signed by the parties.

20. Assignment

20.1 The Supplier shall not assign, in whole or in part, its obligations to

perform under this Contract, except with the Purchaser's prior written consent.

21. Subcontracts

21.1 The Supplier shall notify the Purchaser in writing of all subcontracts awarded under this Contract if not already specified in the bid. Such notification, in the original bid or later, shall not relieve the Supplier from any liability or obligation under the Contract.

21.2 Subcontracts must comply with the provisions of GCC Clause 3.

22. Delays in the Supplier's Performance

22.1 Delivery of the Goods and performance of Services shall be made by the Supplier in accordance with the time schedule prescribed by the Purchaser in the Schedule of Requirements.

22.2 If at any time during performance of the Contract, the Supplier or its subcontractor(s) should encounter conditions impeding timely delivery of the Goods and performance of Services, the Supplier shall promptly notify the Purchaser in writing of the fact of the delay, its likely duration and its cause(s). As soon as practicable after receipt of the Supplier's notice, the Purchaser shall evaluate the situation and may at its discretion extend the Supplier's time for performance, with or without liquidated damages, in which case the extension shall be ratified by the parties by amendment of Contract.

22.3 Except as provided under GCC Clause 25, a delay by the Supplier in the performance of its delivery obligations shall render the Supplier liable to the imposition of liquidated damages pursuant to GCC Clause 23, unless an extension of time is agreed upon pursuant to GCC Clause 22.2 without the application of liquidated damages.

23. Liquidated Damages

23.1 Subject to GCC Clause 25, if the Supplier fails to deliver any or all of the

Goods or to perform the Services within the period(s) specified in the Contract, the Purchaser shall, without prejudice to its other remedies under the Contract, deduct from the Contract Price, as liquidated damages, a sum equivalent to the percentage specified in SCC of the delivered price of the delayed Goods or unperformed Services for each week or part thereof of delay until actual delivery or performance, up to a maximum deduction of the percentage specified in SCC. Once the maximum is reached, the Purchaser may consider termination of the Contract pursuant to GCC Clause 24.

24. Termination for Default

24.1 The Purchaser, without prejudice to any other remedy for breach of Contract, by written notice of default sent to the Supplier, may terminate this Contract in whole or in part:

(a) if the Supplier fails to deliver any or all of the Goods within the period(s) specified in the Contract, or within any extension thereof granted by the Purchaser pursuant to GCC Clause 22; or

(b) if the Supplier fails to perform any other obligation(s) under the Contract.

(c) if the Supplier, in the judgment of the Purchaser has engaged in corrupt or fraudulent practices in competing for or in executing the Contract.

For the purpose of this clause:

"corrupt practice" means the offering, giving, receiving or soliciting of anything of value to influence the action of a public official in the procurement process or in contract execution.

"fraudulent practice" means a misrepresentation of facts in order to influence a procurement process or the execution of a contract to the detriment of the Procuring Agency, and includes collusive practice among Bidders (prior to or after bid submission) designed to establish bid prices at artificial non-competitive levels and to deprive the Procuring Agency of the

benefits of free and open competition.

24.2 In the event the Purchaser terminates the Contract in whole or in part, pursuant to GCC Clause 24.1, the Purchaser may procure, upon such terms and in such manner as it deems appropriate, Goods or Services similar to those undelivered, and the Supplier shall be liable to the Purchaser for any excess costs for such similar Goods or Services. However, the Supplier shall continue performance of the Contract to the extent not terminated.

25. Force Majeure

25.1 Notwithstanding the provisions of GCC Clauses 22, 23, and 24, the Supplier shall not be liable for forfeiture of its performance guarantee, liquidated damages, or termination for default if and to the extent that its delay in performance or other failure to perform its obligations under the Contract is the result of an event of Force Majeure.

25.2 For purposes of this clause, "Force Majeure" means an event beyond the control of the Supplier and not involving the Supplier's fault or negligence and not foreseeable. Such events may include, but are not restricted to, acts of the Purchaser in its sovereign capacity, wars or revolutions, fires, floods, epidemics, quarantine restrictions, and freight embargoes.

25.3 If a Force Majeure situation arises, the Supplier shall promptly notify the Purchaser in writing of such condition and the cause thereof. Unless otherwise directed by the Purchaser in writing, the Supplier shall continue to perform its obligations under the Contract as far as is reasonably practical, and shall seek all reasonable alternative means for performance not prevented by the Force Majeure event.

26. Termination for Insolvency

26.1 The Purchaser may at any time terminate the Contract by giving written notice to the Supplier if the Supplier becomes bankrupt or otherwise insolvent. In this event, termination will be without compensation to the Supplier, provided that such termination will not prejudice or affect any right of action or remedy which has accrued or will accrue thereafter to the

Purchaser.

27. Termination for Convenience

27.1 The Purchaser, by written notice sent to the Supplier, may terminate the Contract, in whole or in part, at any time for its convenience. The notice of termination shall specify that termination is for the Purchaser's convenience, the extent to which performance of the Supplier under the Contract is terminated, and the date upon which such termination becomes effective.

27.2 The Goods that are complete and ready for shipment within thirty (30) days after the Supplier's receipt of notice of termination shall be accepted by the Purchaser at the Contract terms and prices. For the remaining Goods, the Purchaser may elect:

(a) to have any portion completed and delivered at the Contract terms and prices; and/or (b) to cancel the remainder and pay to the Supplier an agreed amount for partially completed Goods and Services and for materials and parts previously procured by the Supplier.

28. Resolution of Disputes

28.1 The Purchaser and the Supplier shall make every effort to resolve amicably by direct informal negotiation any disagreement or dispute arising between them under or in connection with the Contract.

28.2 If, after thirty (30) days from the commencement of such informal negotiations, the Purchaser and the Supplier have been unable to resolve amicably a Contract dispute, either party may require that the dispute be referred for resolution to the formal mechanisms specified in SCC. These mechanisms may include, but are not restricted to, conciliation mediated by a third party, adjudication in an agreed and/or arbitration.

29. Governing Language

29.1 The Contract shall be written in the language specified in SCC. Subject to GCC Clause 30, the version of the Contract written in the specified

language shall govern its interpretation. All correspondence and other documents pertaining to the Contract which are exchanged by the parties shall be written in the same language.

30. Applicable Law

30.1 The Contract shall be interpreted in accordance with the laws of Islamic Republic of Pakistan.

31. Notices

31.1 Any notice given by one party to the other pursuant to this Contract shall be sent to the other party in writing or by fax and confirmed in writing to the other party's address specified in SCC.

31.2 A notice shall be effective when delivered or on the notice's effective date, whichever is later.

32. Taxes and Duties

32.1 Supplier shall be entirely responsible for all taxes, duties, license fees, etc., incurred until delivery of the contracted Goods to the Purchaser.

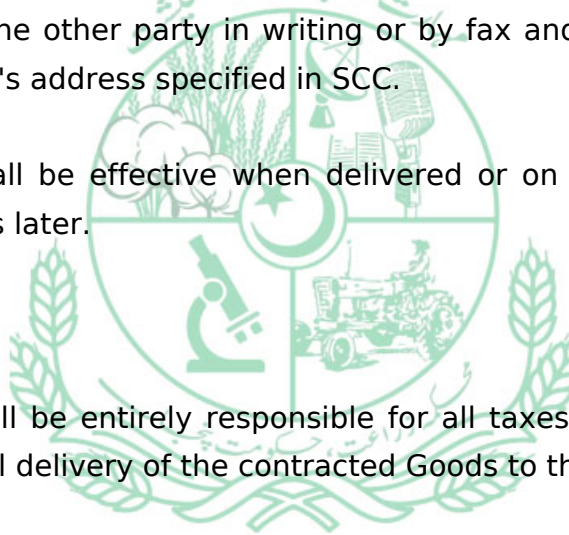

Part-II

Section III. Special Conditions of Contract

The following Special Conditions of Contract shall supplement the General Conditions of Contract. Whenever there is a conflict, the provisions herein shall prevail over those in the General Conditions of Contract. The corresponding clause number of the GCC is indicated in parentheses.

1. Definitions (GCC Clause 1)

GCC 1.1 (g) **The Purchaser is: Principal Scientist, Regional Agricultural Research Institute, Gulberg Road, Model Town-A, Bahawalpur City, Bahawalpur City, Distt. Bahawalpur**

GCC 1.1 (h) **The Purchaser's country is: Islamic Republic of Pakistan**

GCC 1.1 (i) **The Supplier is: [Detail]**

GCC 1.1 (j) The Project Site is:

2. Country of Origin (GCC Clause 3)

Refer to Price Schedule

3. Performance Guarantee (GCC Clause 7)

GCC 7.1 Performance Guarantee is not required.

4. Inspections and Tests (GCC Clause 8)

GCC 8.1

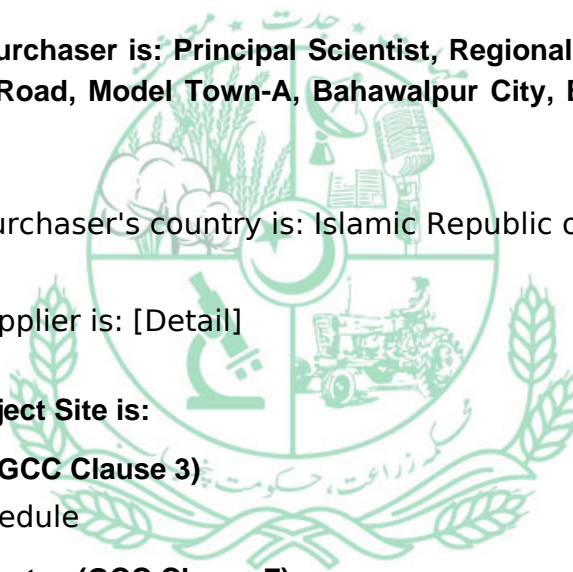

Inspection and tests prior to delivery of goods and at final acceptance are:-

1. For being Brand New, bearing relevant reference numbers of the equipment (Certificate from supplier)
2. For Physical Fitness having No Damages (Certificate from supplier)
3. For the Country of Origin as quoted by the Supplier (Certificate from manufacturer)
4. For conformance to specifications and performance parameters, through Prior to delivery inspection (Inspection Report by Procurement Committee / Inspection Team)
5. For successful operation at site after complete installation, testing and commissioning of the equipment (Installation, Testing and Commissioning Report by Procurement Committee / Inspection Team)

5. Delivery and Documents (GCC Clause 10)

GCC 10.3 Upon shipment, the Supplier shall notify the Purchaser the full details of the shipment, including Contract number, description of Goods, quantity and usual transport document. The Supplier shall mail the following documents to the Purchaser:

1. Copies of the Supplier's invoice showing Goods' description, quantity, unit price, and total amount;
2. Original and two copies of the usual transport document (for example, a negotiable bill of lading, a non-negotiable sea waybill, an inland waterway document, an air waybill, a railway consignment note, a road consignment note, or a multimodal transport document) which the buyer may require to take the goods;
3. Copies of the packing list identifying contents of each package;
4. Insurance Certificate;

5. Manufacturer's or Supplier's Valid Warranty Certificate;
6. Inspection Certificate issued by the Nominated Inspection Agency (if any), and the Supplier's Factory Inspection Report;
7. Certificate of Origin.
8. The above documents would be required even if the equipment has already been imported and is available with the supplier ex-stock

6. Incidental Services (GCC Clause 13)

GCC 13.1 Incidental services to be provided are:

1. At site complete training of Purchaser's nominated staff regarding maintenance and operation of Goods.
2. At site preventive maintenance on quarterly basis by the bidder's qualified staff for one year, starting from final acceptance of goods. The rate must include cost for all kinds of labor, inputs and material required for above, and all applicable government taxes and levies. In case a separate rate is not provided by the bidder for the above items, it shall be deemed to have been covered in the overall quoted cost.

7. Warranty (GCC Clause 15)

8. 1- One year free warranty for parts and service.
2- Extended 5 years for parts, supply on payment.

9. Payment (GCC Clause 16)

GCC 16.1 The method and conditions of payment to be made to the Supplier

under this Contract shall be:

1. in Pakistani Rupees (PKR),
2. upon submission of claim, &
3. within thirty (30) days of receipt of the Goods at site after performing the requisite inspection and tests as mentioned in SCC 4.

10. Prices (GCC Clause 17)

GCC 17.1 Prices shall be: Fixed.

11. Liquidated Damages (GCC Clause 23)

GCC 23.1 Applicable rate: 0.00 % of contract price per day Maximum deduction: 0.00 % of contract price

12. Resolution of Disputes (GCC Clause 28)

GCC 28.3 The dispute resolution mechanism to be applied pursuant to GCC Clause 28.2 shall be as follows:

In the case of a dispute between the Purchaser and the Supplier, the dispute shall be referred to adjudication or arbitration in accordance with the Pakistan Arbitration Act, 1940.

13. Governing Language (GCC Clause 29)

GCC 29.1 The Governing Language shall be: English.

14. Applicable Law (GCC Clause 30)

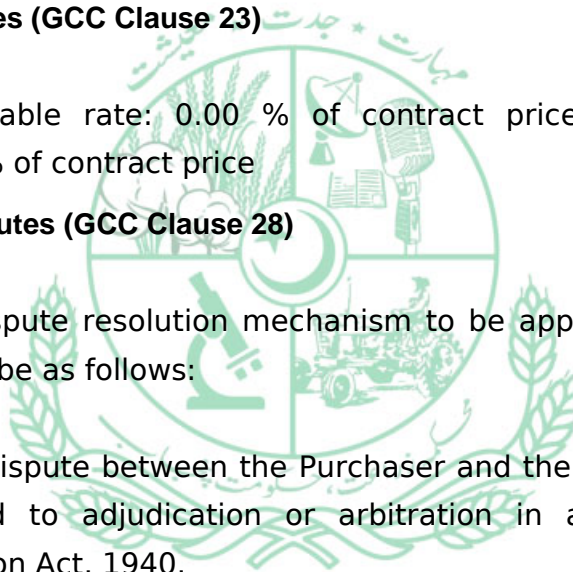

GCC 30.1-The Contract shall be interpreted in accordance with the laws of Islamic Republic of Pakistan:

15. **Notices (GCC Clause 31)**

GCC 31.1---Purchaser's address for notice purposes --- **Regional Agricultural Research Institute, Gulberg Road, Model Town-A, Bahawalpur City, Bahawalpur City, Distt. Bahawalpur**

---Supplier's address for notice purposes:



Items' Drawing and Specifications



Vogal wheat thresher

VOGAL WHEAT THRESHER

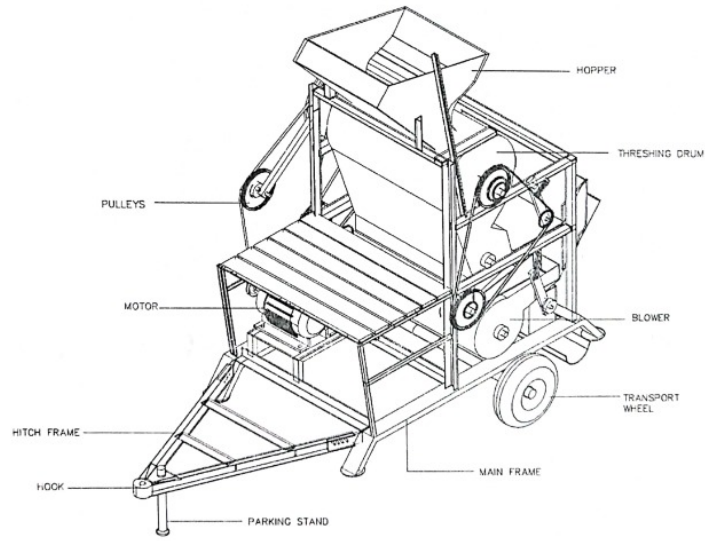

Annexures



Undertaking for Correctness of Information and Non-Blacklisting

(To be provided on the letterhead of Bidder)

I, the undersigned, do hereby certify that all the statements made in this application / bid and in the supporting documents are true, correct and valid to the best of my knowledge and belief and may be verified by Procuring Agency at any time, if deems it necessary.

That the undersigned hereby authorize and request the bank, person, firm or corporation to furnish any additional information requested by the Procuring Agency deemed necessary to verify this statement regarding my (our) competence and general reputation.

That the undersigned understands and agrees that further qualifying information may be requested and I agree to furnish any such information at the request of the Procuring Agency.

That the undersigned / Applicant is not insolvent and not blacklisted by any of Provincial or Federal Government Department, Agency, Organization, NGO, INGO, IGO, or any other autonomous or corporate body anywhere in Pakistan.

The undersigned certify that my firm / company is not involved in *litigation or arbitration and has not been declared ineligible / debarred by any of the Federal / Provincial Government or any other entity due to any reason whatsoever and is eligible to carry out the business in Pakistan for which this Bid / Application for Prequalification is being made.

Signed by an authorized representative

Name of the Bidder: _____

Date: _____

In case of involvement of applicant / bidder in any litigation or arbitration, current status or the proof of dispute resolution along with the history of litigation / arbitration for **last ten years on Litigation History Form (See Annexures) shall be provided with the bid.*



Certificates

(To be provided by the bidders on letterhead alongwith tender duly filled in, signed and stamped)

1.	We hereby confirm to have read carefully the description of stores and all the terms and conditions of your tender enquiry No. Vogal Wheat thresher-2022 due for opening on Wednesday, 10th August, 2022 11:30 AM for the supply of specified stores in addition to the conditions as appended herewith and also all the special instructions attached to the said tender enquiry. We agree to abide by all those instructions/conditions.
2.	We also hereby confirm that the stores offered by us are exactly to the particulars and specifications as laid down in your tender enquiry in all respects.
3.	The stores offered by us are of (a) foreign origin or (b) local origin.
4.	We accept that if the required Bid Security is not furnished or our offer is found lacking in any of the requirement of your tender enquiry, it shall be ignored.
5.	We hereby confirm to understand that the delivery period is the essence of the contract and it will be strictly adhered to by us. In case of failure we agree that contract shall stand cancel and performance guarantee shall be forfeited and procuring agency reserves the right to purchase the store from elsewhere without any notice at the risk and cost of defaulting contractor.
6.	Certified that the prices quoted to the department against tender No. Vogal Wheat thresher-2022 are not more than the prices, we charged from any other purchasing agencies in the country. In case of any discrepancy, the bidder hereby undertakes to refund the price charged in excess.
7.	We are responsible for the free replacement of stores if the same is found to be substandard or not suitable for the Machine/Engine/Equipment or at variance with the specifications given in the tender enquiry.

8.	We guarantee to supply stores exactly in accordance with the requirements specified in the invitation to Tender No. Vogal Wheat thresher-2022
	Name of bidder _____ Signature of bidder _____ Designation of bidder _____ Seal _____

Witness:

- a. Name _____ **Signature** _____
- b. Full Address _____
- c. Date _____

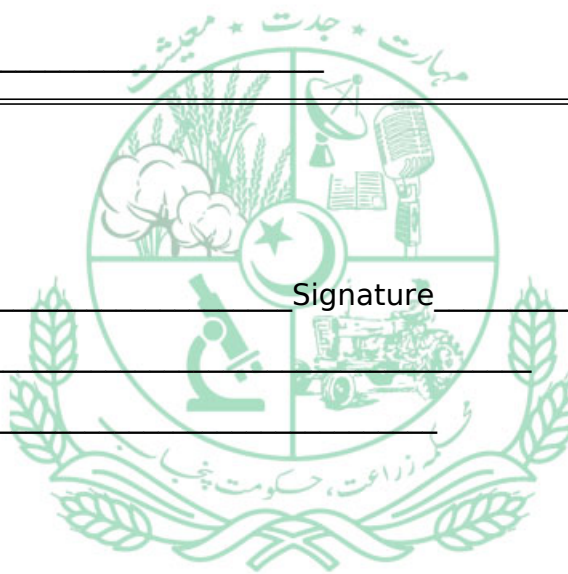

Power of Attorney (For signatory of Application)

[To be printed on a PKR 100 stamp paper]

KNOW ALL MEN BY THESE PRESENTS THAT by this Power of Attorney(“**Power of Attorney**”), _____ [*Insert name firm/Company*] having its registered office at [-----], does hereby nominate, appoint and authorize Mr. _____, having CNIC No. _____ hereinafter referred to as the “**Signatory of Application**”, to do in our name and on our behalf the following:

- i. Sign and submit to _____ or its authorized nominee, the Prequalification Application / Bid for “**PURCHASE OF VOGAL WHEAT THRESHER**”, in response to the advertisement dated [---] issued by The Procuring Agency and all other documents and instruments required to submit the Prequalification Application / Bidding Documents.
- ii. execute all such contracts, deeds, documents and instruments as may be considered necessary and expedient in relation to the foregoing; and
- iii. do and carry out all other actions as may be required by the Procuring Agency in connection with the Prequalification / bidding process as a whole;
- iv. To immediately notify The Procuring Agency in writing of any impending or actual revocation as well as any change in the terms of this Power of Attorney.
- v. To do in our name and on our behalf, all such acts, deeds and things necessary in connection with or incidental to our Prequalification / Bid in response to the above referred Advertisement including signing and submission of all documents, instruments and deeds (including correcting any deficiencies or mistakes therein), attending any meetings organized by the Procuring Agency (including pre-bid conference meetings and bid opening meetings)and providing information/responses to the Procuring Agency in all matters in connection with our Bid.

We, [*Insert name of Firm/Company*], do hereby ratify and confirm whatsoever the Signatory of Application shall do by virtue of these presents and further agree that whatever the Signatory of Application shall do or cause to be done pursuant

to this Power of Attorney shall be binding on us.

Furthermore, each provision of this Power of Attorney is severable and distinct from the others. The invalidity, illegality or unenforceability of any one or more provisions of this Power of Attorney at any time shall not in any way affect or impair the validity, legality and enforceability of the remaining provisions hereof.

IN WITNESS WHEREOF, we have executed this **POWER OF ATTORNEY** as of [Date].

FOR: [INSERT NAME OF BIDDER]

Signature: _____
Name: _____
Title: _____
CNIC/Passport No. : _____



